



M3/M4-5AX

Total Solution 5-Axis Universal Machining Center



Contents

Product Overview

Basic Information

- Basic Structure ————— • 06
- Cutting Performance ————— • 08

Detailed Information

- Standard / Optional Accessories Status → • 10
- Hwacheon Software ————— • 15
- Diagram ————— • 16
- Machine / NC Specifications ————— • 18

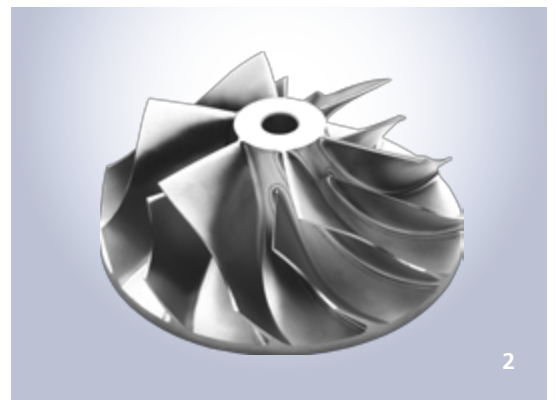

1 Tire Mold / Aluminum (M3-5AX)
2 Impeller / SUS321 (M3-5AX)
3 Herringbone Gear / SM45C (M4-5AX)

High-precision, High-rigid 5-axis machining center specialized for hard-to-machine materials

M3-5AX and M4-5AX are 5-axis machining centers that are specialized for machining molds and parts that have complex shapes and require high precision. They are mounted with a high-precision, high-rigid rotary table that is developed with Hwacheon's technology. Especially, M4-5AX offers the optimal machining quality through its design that is optimized for the machining of difficult-to-cut materials. Their high-rigidity, high-performance spindle and Hwacheon's 5-axis software technology offer precise and fast machining environment, ensuring satisfactory results.



Upgrades for Enhanced Machining Performance

- 1 Three LM Guides for X Axis (M4-5AX)
- 2 High-rigid LM guide
- 3 Twin drive structure for Y axis and 6 LM blocks
- 4 Application of scale feedback for all axes
- 5 High loading capacity M3-5AX : 800kg_f
M4-5AX : 1,200kg_f

5-axis Machining Solution

- 1 Hwacheon Rotation Center Calibration System (HRCC II)
- 2 0.0001° high-precision rotary table
- 3 Twin drive structure for A axis to minimize distortion
- 4 Application of rotary table cooling system

Enhanced User Convenience

- 1 Convenient accessibility to work area
- 2 Automatic ceiling opening/closing system
- 3 Rapid chip discharge structure

5-AXIS UNIVERSAL MACHINING CENTER WITH MACHINING SOLUTION

High-precision, high-rigid 5-axis machining solution that completes the whole process with one-time setup

It can machine products that require simultaneous 5-axis machining or have complex shape, requiring multiple processes, with one-time setup. It solves a problem of limited tool length due to the machined shape and can machine using the side and bottom surface of the tool, greatly reducing the machining time, extending the life span of the tool, and providing improved machining quality at the same time.

High-Efficiency Multi-Axis Machining

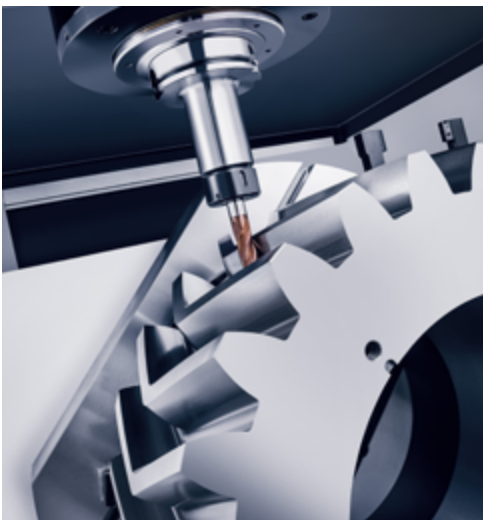
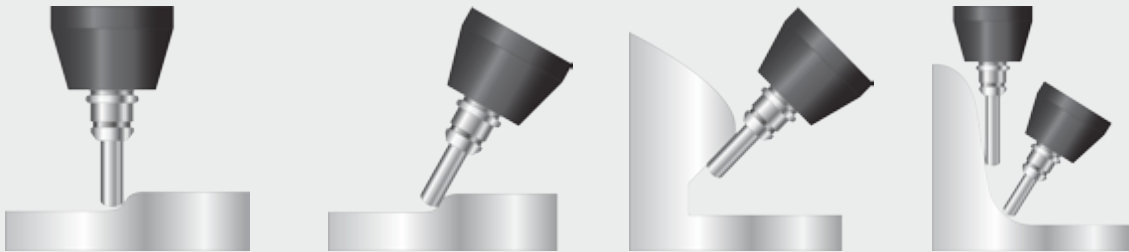

5-Axis Machining Solution

" HWACHEON M Series "

- ▶ High-Rigid Spindle
- ▶ High-precision Rotary Table
- ▶ High-Rigid Frame
- ▶ Hwacheon 5-Axis Software

A 5-axis machine tool that can machine products that require multiple processes with "one-time setup."

Hwacheon's Solution Optimized for Tire Mold Machining (OPT)

This machining solution measures multiple processes (OP10, OP20, and OP30) for machining the tire mold with a 5-axis machine tool and a work probe and compensates for product installation deviations, enabling the complete machining of detailed processes automatically.

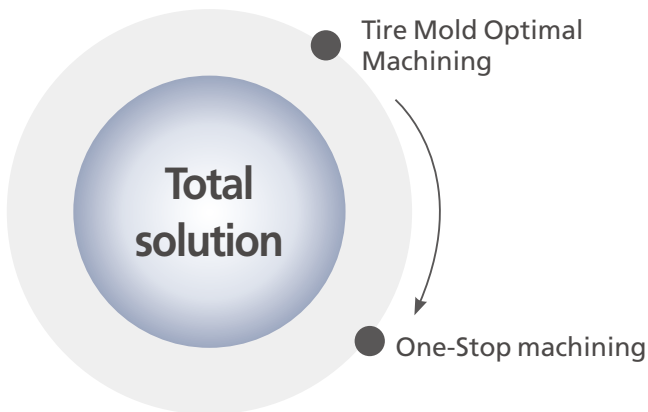

- Improved productivity with one-stop machining
- Can set up the machine for various types of workpieces
- Reduced the dependency on workers' skill
- Reduced the fatigue of workers
- Easy to identify defects in all processes
- Reduced the product defect rate



Solution OP10

Machining of Top and Side Surfaces

- Measures the cast material and machines all surfaces except for the bottom

Solution OP20

Machining of Back Surface

- Machines the back surface shape based on the inner arc surface and side of the product that are already machined (Replaces the existing turning process)

Solution OP30

Finishing Process for Assembly

- Process for removing minute angle errors and adjusting the accumulated gap generated from the assembly process (Replaces the existing manual process for horizontal milling)

Basic Information

Basic Structure



"Machining Stability Ensured"

- Stable machine structure
(Outstanding rigid base and column structure ensured)
- Application of scale feedback for all axes
- High rigid LM guide for every axis

	Stroke mm (inch)			Rapid Speed m/min (ipm)			Tilt Angle deg	Rotation Angle deg
	X-axis	Y-axis	Z-axis	X-axis	Y-axis	Z-axis	A-axis	C-axis
M3-5AX	750 (29.53)	900 (35.43)	550 (21.65)	48 (1,890)	48 (1,890)	40 (1,575)	±120	360°
M4-5AX	950 (37.4)	1,000 (39.37)	650 (25.59)	36 (1,417)	36 (1,417)	30 (1,181)		

"High-rigid X, Z-axis structure"

M3-5AX

- Guide structure whose rigidity does not change depending on the height of Z-axis
- Minimized the deformation of the main spindle when machining for a long duration by optimizing the gap between the main spindle and the frame

M4-5AX

- Three LM Guide Rails & Six LM Blocks for X Axis
- Z-Axis Box Way Structure For Fast Absorption of Machining Vibration
- Guide structure whose rigidity does not change depending on the height of Z-axis
- Minimized the deformation of the main spindle when machining for a long duration by optimizing the gap between the main spindle and the frame

Three LM Guide Rails for X Axis
(M4-5AX)

Optimized the gap between the
main spindle and the frame



"High-rigid, high-precision Y axis structure"

Forms multiple LM guide support points or smooth feeding and high rigidity

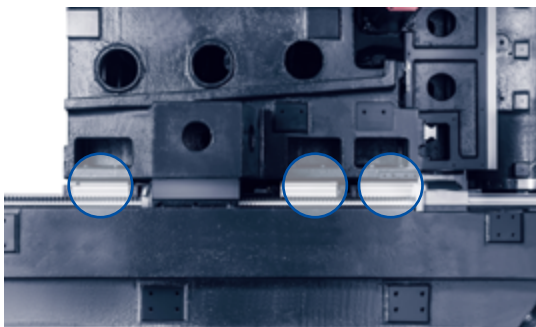

(Y-axis LM Block)

Six LM blocks for Y axis
to improve machining precision

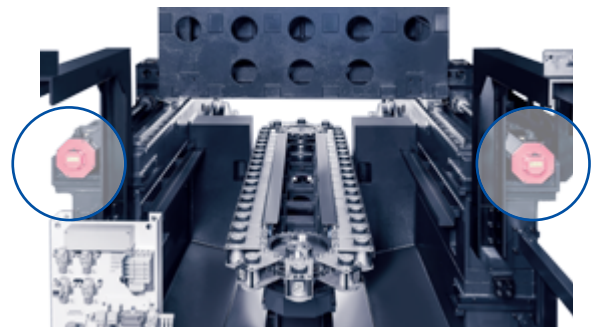

(Y-axis Twin Drive)

Twin drive structure to minimize yawing
that occurs during the axis feeding

Table

"High-precision rotary table"

- Application of 0.0001° rotary encoder as standard
- Application of an external motor and cooling system
(Minimize the heat from the motor)
- Application Of twin drive (Minimize the distortion)

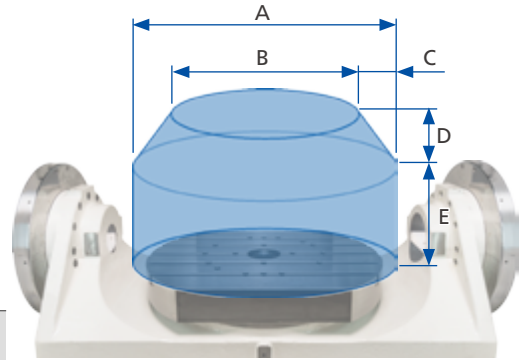

	Table Size mm (inch)	Max Loading Capacity kg, (lb.)	T Slot W x P mm (inch)	Minimum rotation angle deg
M3-5AX	Ø700 x 540 (Ø27.56 x 21.26)	800 (1,764)	18 x 100 (0.71 x 3.94) / 5ea	0.0001°
M4-5AX	Ø800 x 630 (Ø31.5 x 24.8)	1,200 (2,646)		

A	M3-5AX : Ø840 (Ø33.07) M4-5AX : Ø1,050 (Ø41.34)	D	M3-5AX : 170 (6.69) M4-5AX : 352 (13.86)
B	M3-5AX : Ø500 (Ø19.69) M4-5AX : Ø470 (Ø18.5)	E	M3-5AX : 330 (12.99) M4-5AX : 208 (8.19)
C	M3-5AX : 170 (6.69) M4-5AX : 290 (11.42)		

Spindle



Meeting the customer's machining purposes

"Various Specifications for Built-in motor Spindles"

	M3-5AX			M4-5AX	
	(STD) BBT-40 (OPT) CAT-40, HSK-A63, SK-40			(STD) BBT-50 (OPT) CAT-50, HSK-A100, SK-50	
	High Speed		High Torque	High Speed	High Torque
Max Spindle Speed rpm	20,000	24,000	14,000	12,000	8,000
Spindle Motor kW	22	37	37	30	55
Max Torque Nm	117.7	221	303	420	1,009

Magazine

"Magazines in Various Specifications"

Various specifications are available based on users' tool types

Tool Shank	M3-5AX	M4-5AX
Item	(STD) BBT-40 (OPT) CAT-40, HSK-A63, SK-40	(STD) BBT-50 (OPT) CAT-50, HSK-A100, SK-50
Magazine Type	Chain Type	
Tool Storage Capacity	40 (OPT : 60, 90)	30 (OPT : 60)
Drive Type	Servo Motor	
Tool Change Type	Swing Arm	

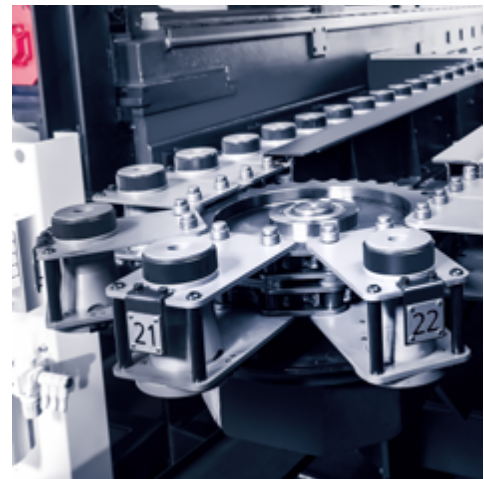

Basic Information

M3-5AX Cutting Performance

· Material : SM45C

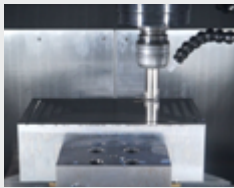

Face mill, Carbon Steel					
Tool Dia mm (inch)	Material Removal Rate cm ³ /min	Spindle Speed rpm	Feed mm/min (ipm)	Axil Depth mm (inch)	Radial Depth mm (inch)
33 (1.3) / R2.5 (R0.1)	144	2,000	6,000 (236)	1 (0.04)	24 (0.94)

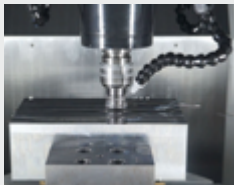

Face mill, Carbon Steel					
Tool Dia mm (inch)	Material Removal Rate cm ³ /min	Spindle Speed rpm	Feed mm/min (ipm)	Axil Depth mm (inch)	Radial Depth mm (inch)
50 (1.97) / R8 (R0.31)	180	1,200	1,800 (70.9)	2 (0.08)	50 (1.97)

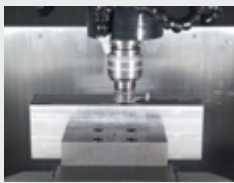

Face mill, Carbon Steel					
Tool Dia mm (inch)	Material Removal Rate cm ³ /min	Spindle Speed rpm	Feed mm/min (ipm)	Axil Depth mm (inch)	Radial Depth mm (inch)
50 (1.97) / R8 (R0.31)	216	1,800	1,350 (53.2)	4 (0.16)	40 (1.57)

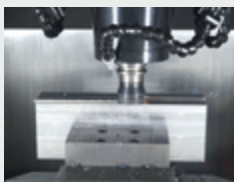

Face mill, Carbon Steel					
Tool Dia mm (inch)	Material Removal Rate cm ³ /min	Spindle Speed rpm	Feed mm/min (ipm)	Axil Depth mm (inch)	Radial Depth mm (inch)
60 (2.36)	160	1,600	800 (31.5)	5 (0.2)	40 (1.57)

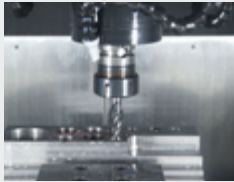

Tap, Carbon Steel			
Tap Size mm (inch)	Spindle Speed rpm	Feed mm/min (ipm)	Spindle Load %
M24 x P3.0 (M0.94 x P0.12)	400	1,200 (47.2)	48

M4-5AX Cutting Performance

· Material : SM45C

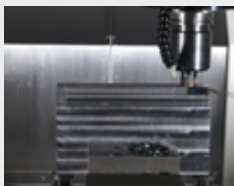

Face mill, Carbon Steel					
Tool Dia mm (inch)	Material Removal Rate cm ³ /min	Spindle Speed rpm	Feed mm/min (ipm)	Axil Depth mm (inch)	Radial Depth mm (inch)
40 (1.57)	235	540	294 (11.6)	20 (0.79)	40 (1.57)

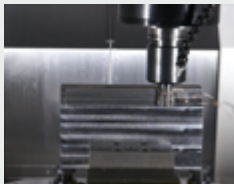

Face mill, Carbon Steel					
Tool Dia mm (inch)	Material Removal Rate cm ³ /min	Spindle Speed rpm	Feed mm/min (ipm)	Axil Depth mm (inch)	Radial Depth mm (inch)
40 (1.57)	432	800	540 (21.3)	40 (1.57)	20 (0.79)



Face mill, Carbon Steel					
Tool Dia mm (inch)	Material Removal Rate cm ³ /min	Spindle Speed rpm	Feed mm/min (ipm)	Axil Depth mm (inch)	Radial Depth mm (inch)
63 (2.48) / R8 (R0.31)	962	1,500	4,810 (189.4)	4 (0.16)	50 (1.97)

* The machining results above are examples based on the factory test standards, and are subjected to the changes in conditions.

M4-5AX Cutting Performance

· Material : SM45C

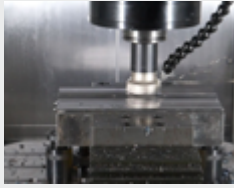

Face mill, Carbon Steel					
Tool Dia mm (inch)	Material Removal Rate cm ³ /min	Spindle Speed rpm	Feed mm/min (ipm)	Axil Depth mm (inch)	Radial Depth mm (inch)
80 (3.15) / R2.5 (R0.1)	792	1,500	11,000 (433)	1.2 (0.05)	60 (2.36)



Face mill, Carbon Steel					
Tool Dia mm (inch)	Material Removal Rate cm ³ /min	Spindle Speed rpm	Feed mm/min (ipm)	Axil Depth mm (inch)	Radial Depth mm (inch)
160 (6.3)	549	600	286 (11.26)	12 (0.5)	160 (6.3)

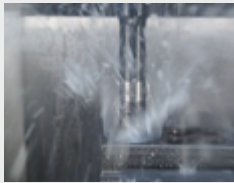

U-Drill, Carbon Steel				
Tool Dia mm (inch)	Material Removal Rate cm ³ /min	Spindle Speed rpm	Feed mm/min (ipm)	Spindle Load %
85 (3.34)	454	600	80 (3.15)	

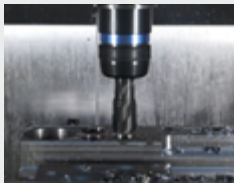

Tap, Carbon Steel			
Tap Size mm (inch)	Spindle Speed rpm	Feed mm/min (ipm)	Spindle Load %
M42 x P4.5 (M1.65 x P0.18)	490	2,205 (86.8)	IN : 70 / OUT : 103

· Material : KP4M



Face mill, Mold Steel					
Tool Dia mm (inch)	Material Removal Rate cm ³ /min	Spindle Speed rpm	Feed mm/min (ipm)	Axil Depth mm (inch)	Radial Depth mm (inch)
63 (2.48) / R8 (R0.31)	405	1,500	1,800 (70.9)	5 (0.2)	45 (1.77)

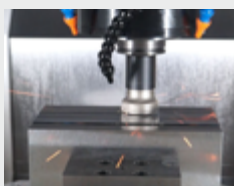

Face mill, Mold Steel					
Tool Dia mm (inch)	Material Removal Rate cm ³ /min	Spindle Speed rpm	Feed mm/min (ipm)	Axil Depth mm (inch)	Radial Depth mm (inch)
80 (3.15) / R2.5 (R0.1)	454	1,500	6,300 (248)	1.2 (0.05)	60 (2.36)

· Material : Ti-6AL-4V



End mill, Titanium Alloy					
Tool Dia mm (inch)	Material Removal Rate cm ³ /min	Spindle Speed rpm	Feed mm/min (ipm)	Axil Depth mm (inch)	Radial Depth mm (inch)
50 (1.97) / L50 (L1.97)	392	490	392 (15.43)	50 (1.97)	20 (0.79)

* The machining results above are examples based on the factory test standards, and are subjected to the changes in conditions.

Detailed Information

Standard / Optional Accessories Status

- : Not available S : Standard O : Option

NO.	Item	Description	M3-5AX	M4-5AX
1	Spindle	20,000 rpm	S	-
2		#40 24,000 rpm	O	-
3		14,000 rpm	O	-
4		#50 12,000 rpm	-	S
5		8,000 rpm	-	O
6	Magazine	#40 40 Tools Magazine	S	-
7		60 Tools Magazine / 90 Tools Magazine	O	-
8		#50 30 Tools Magazine	-	S
9		60 Tools Magazine	-	O
10	Tool Shank	#40 BBT-40	S	-
11		CAT-40, HSK-A63, SK-40	O	-
12		#50 BBT-50	-	S
13		CAT-50, HSK-A100, SK-50	-	O
14	Coolant Function	Head Flushing (0.12 MPa, 0.75 kW)	-	S
15		CTS Coolant Device	3 MPa	O
16			7 MPa	O
17		Oil Mist (Semi dry cutting system)	-	O
18	Chip Removal Function	Air Blower	S	S
19		Air Gun	S	S
20		Coolant Gun	S	S
21		Lift-up Chip Conveyor	O	O
22		Mist Collector	O	O
23	Precision Machining Function	Linear Scale (X / Y / Z)	S	S
25		Hwacheon Efficient Contour Control System (HECC)	S	S
26		Hwacheon Thermal Displacement Control System (HTDC) [Hwacheon Spindle Displacement Control System (HSDC) + Hwacheon Frame Displacement Control System (HFDC)]	S	S
27		Hwacheon Artificial Intelligence Control System (HAI) - 600 Block	S	S
28		Hwacheon Artificial Intelligence Control System (HAI) - 1000 Block	O	O
29		Lubrication System	S	S
30		Spindle Cooler (Oil-Jet + Jacket Cooling)	Oil Cooler Type	S
31	Table Cooler (Jacket Cooling)	Oil Cooler Type	S	S
32	Measuring & Automation Function	Tool Measuring System – Renishaw / Blum (Touch Type, Laser Type)	O	O
33		Workpiece Measuring System – Renishaw / Blum (Touch Type)	O	O
34		Tool Life Management	O	O
35		Auto Door	O	O
36		Hwacheon Tool Load Detect System (HTLD)	S	S
37		Cutting Feed Optimization System (OPTIMA)	S	S
38		Hwacheon Rotation Center Calibration System (HRCC II)	O	O
39	Convenient Functions	Ethernet Interface	S	S
40		MPG Handle (1ea)	S	S
41		Signal Lamp with 3 Color (R, G, Y)	S	S
42		10.4" Color LCD	S	S
43		Tool Box	S	S
44		NC Cooler	O	O
45		Oil Skimmer	O	O
46		Air Dryer	O	O
47		Door Interlock	S	S
48		Workpiece Coordinate System 48 pairs	S	S
49		Lubrication Oil Separation Tank	S	S
50		Perfect Base Around Splash Guard	S	S
51		Part Program Storage Length 256 kB (500ea)	S	S
52		Data Server (256 MB)	S	S
53		Data Server (1,024 MB)	O	O
54		Data Server Interface	S	S
55		Manual Guide i	O	O
56		Monitoring Solution of Real-time Operational Status (M-VISION Plus)	O	O

HIGH-PRODUCTIVITY and USER FRIENDLY DESIGN

High Productivity and User Convenience

The product is mounted with a high-precision, high-rigidity rotary table developed with Hwacheon's technology as well as the HRCC II, a Hwacheon 5-axis software, providing high-quality machining results. Also, with its user-friendly design, the machine is easy to maintain, offering convenience in its management and use.



"High-precision Rotary Table"

The rotary table, which Hwacheon developed on its own, maintains high precision during a long-time machining with a design that minimizes the distortion that occurs during the machining.



"Rapid Chip Discharge Structure"

Vertical inner structure allows rapid discharge of chips by transferring a large volume of chips produced during machining through the chip conveyor, allowing you to maintain the machine conveniently and keep the inside of the machine clean.

Cooling System

		Jacket Cooling	Bearing Lubrication
M3-5AX	20,000 rpm (STD)	Oil Cooler	Oil-jet Type
	24,000 rpm (OPT)		
	14,000 rpm (OPT)		
M4-5AX	12,000 rpm (OPT)		
	8,000 rpm (OPT)		

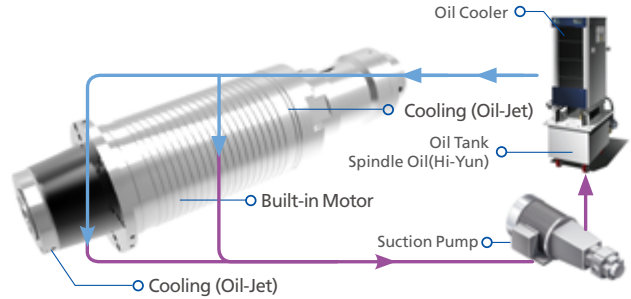

Chip Conveyor

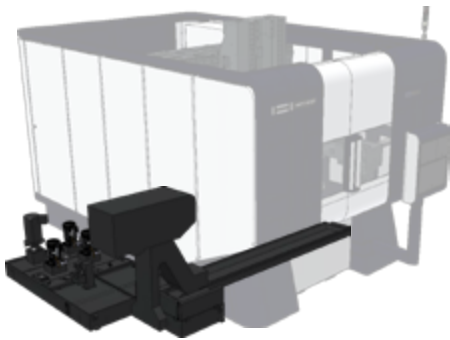

Left direction discharge
Lift-up Chip Conveyor

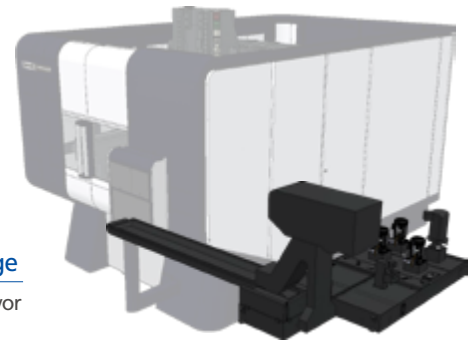

Right direction discharge
Lift-up Chip Conveyor

"The chip conveyor may be installed differently according to the usage environment"

Coolant and Chip Removal

"Efficient coolant tank construction"

External Coolant Tank Tank Capacity : 430 l (113.59 gal)
 - External coolant tank is installed at the side of machine. Easy to exchange coolant, clean the tank and maintain pump

· Coolant Pump Specification

- Using Oil - Viscosity of ISO VG 32 or less
- Head Coolant Pump - Power : 0.75 kW
- Coolant Gun Pump - Power : 1.1 kW
- CTS Coolant Pump (OPT) - Pressure : 3 MPa / 7 MPa
 - Power : 2.2 kW



Convenient Operator Panel

90° Rotating Operator Panel (STD)



The operator panel is newly designed from the operator's viewpoint and thus enhances the operator's convenience.

"User Friendly Design"

- 10.4" display as standard (USB and PCMCIA cards as standard)
- Enhanced operability by optimizing the layout and improving the touch feeling of control buttons
- Horizontal keys enhance user convenience
- Separately mounting MPG for workpiece setting convenience.
- Long time continuous DNC operation with the CF card even without the data server.

Machine Optimization (STD)

- Smart rigid tap function applied for machining time reduction.
- The cycle machining as well as the operating time and the acceleration / deceleration speed of feeding system are optimized.
- High-level precision, speed and smoothness are realized by enhanced processing performance of tiny segments.
- Dramatically reduced non-cutting time during machining ensures optimal productivity.
- The latest machining technology adopted.
- Machining surface quality enhanced by HRV3 control. (HRV3: effectively prevents machine oscillation by controlling the servo current to enhance the machining surface quality.)

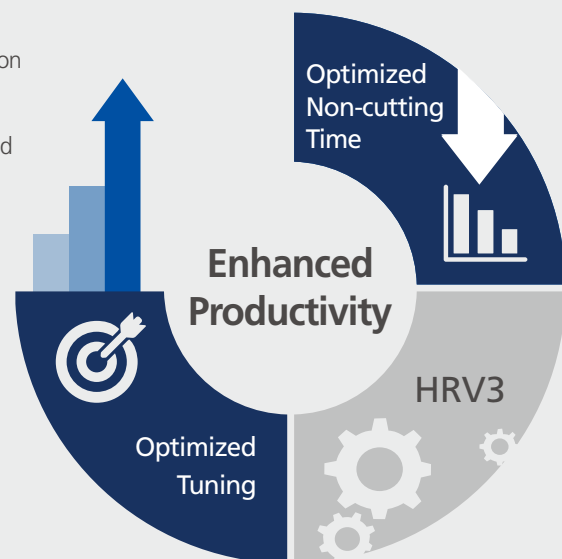

"Enhanced Productivity"

• Detailed Information

Operating Convenience Function

< M-CODE LIST >



- M-CODE LIST
- The screen provides easy and quick search and utilization.

(However, it is necessary to discuss with factory in advance to add and / or change M-codes.)

< GUI (Graphical User Interface) >



- Graphic interface for tool / workpiece measurement
- Automatic offset update function
- Tool setting and damaged tool detection, Workpiece setup and measuring while machining
- Optimized time and failure rate High competitiveness

< Tool Management >

Large / Small Diameter Tool Management System

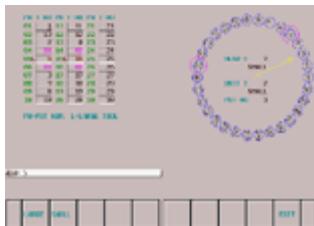

- Magazine tool management system
- Magazine tool check in real time
- Large / small diameter tools setting

< Tool View >



- Head mounted tool check in real time
- Waiting pot mounted tool check in real time

Manual Guide i

With the Manual Guide i, the operator is able to create a machining program for the desired geometry including the pattern simply if he / she enters numeric values for the basic machining geometry.



• Programming in convenient functions and rich machining cycles



• The realistic machining simulation checks the program.



• It displays the machine status and the tools in use while machining.



Hwacheon Tool Load Detect System

"Detect and diagnose the most minute of tool-end point movement"

HTLD constantly monitors the tool wear to prevent accidents, which may occur from a damaged tool and help to stop tool wear from deteriorating the workpiece.
(The load is measured every 8 msec to ensure accuracy.)



Hwacheon High Efficiency Contour Control System

"Roughing quickly, finishing is precisely"

HECC offers an easy to use programming interface for different workpieces and different processing modes. The system provides a precise, custom contour control for the selected workpiece, while prolonging the life of the machine and decreasing process time. The customizable display provides real-time monitoring and quick access.



Cutting Feed Optimization System

"Maximize your productivity with intelligent system"

OPTIMA utilizes an adaptive control method to regulate the feed rate in real time, to sustain the cutting load during a machining process. As a result the tools are less prone to damage and the machining time is optimized.



Hwacheon Spindle Displacement Control System

"Real-time correction for the displacement in the spindle"

When the spindle rotates at high speed, the centrifugal force drives the taper to expand, causing errors in Z axis. HSDC constantly monitors the temperature at each spindle region and makes optimal prediction for thermal displacement. The system then makes necessary adjustments and effectively minimizing thermal displacement.



Hwacheon Frame Displacement Control System

"System for maintaining processing accuracy for a long period of machining"

HFDC is equipped with highly sensitive thermal sensors in the casting region where thermal activity is suspected; monitoring and correcting displacement.



Hwacheon Thermal Displacement Control System

"Hwacheon Spindle Displacement Control System + Hwacheon Frame Displacement Control System"

HTDC integrates the Hwacheon Spindle Displacement Control system and the Frame Displacement Control System.



Hwacheon Rotation Center Calibration System

"Completes Complex 5-axis process with one-time setup"

The HRCC is used to calibrate and optimize the rotation center of 5-axis machining equipment. By optimizing the rotation center, then managing and loading the relevant data, you can minimize the possibility of errors during 5-axis machining.



Monitoring Solution of Real-time Operational Status

"See everything everywhere"

- Monitoring system for the User's factory machine management
- User can always check the status of the machine utilizes a smartphone

M4-5AX Machine Size

* Unit: mm(inch)

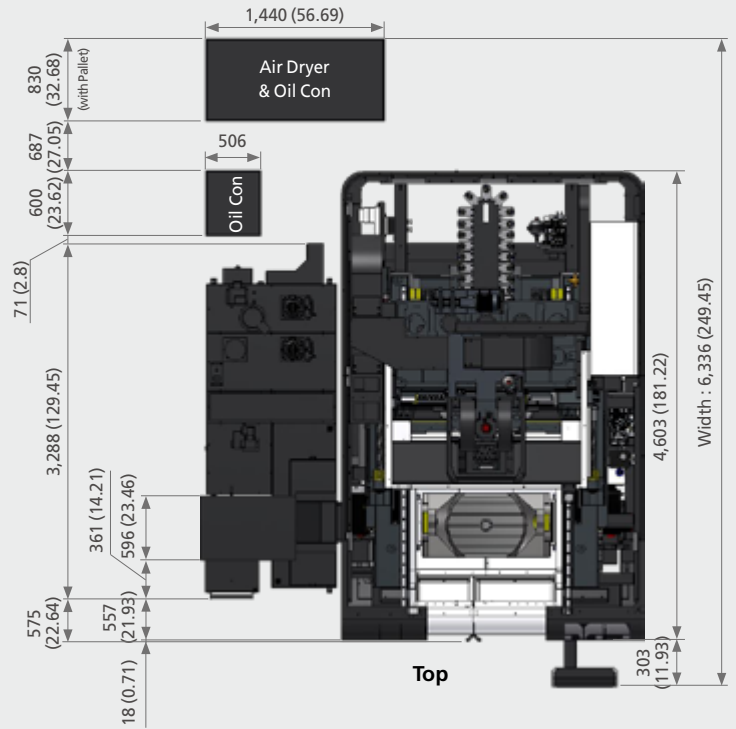

Top

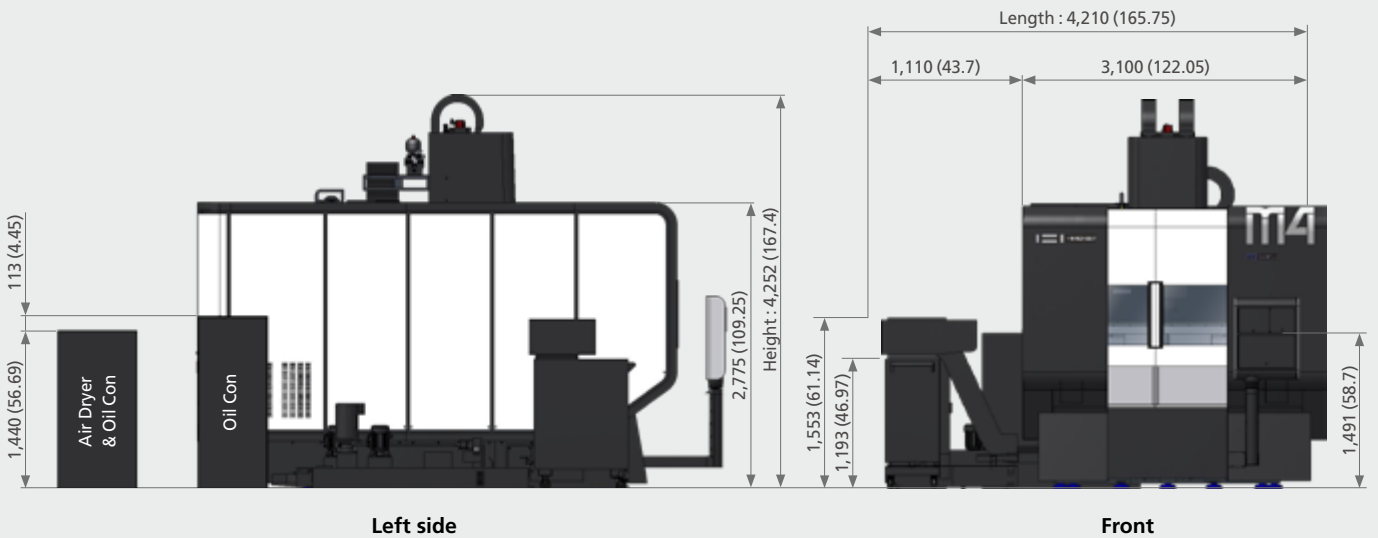

Left side

Front

Spindle Power – Torque Diagram

12,000 rpm

Max Power : 30 kW (40 HP) / Max Torque : Max Torque : 420 Nm

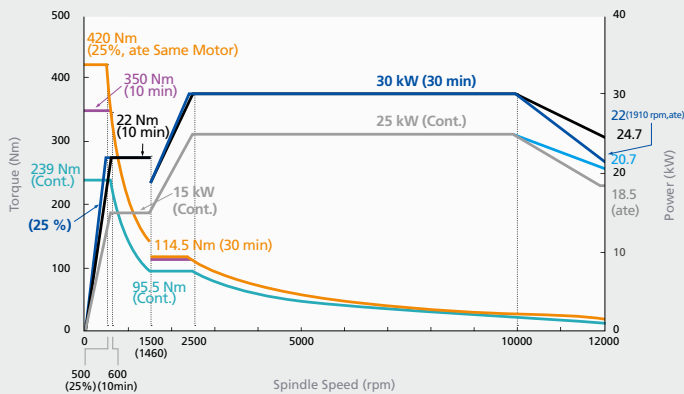

8,000 rpm (OPT)

Max Power : 55 kW (73 HP) / Max Torque : 1009 Nm

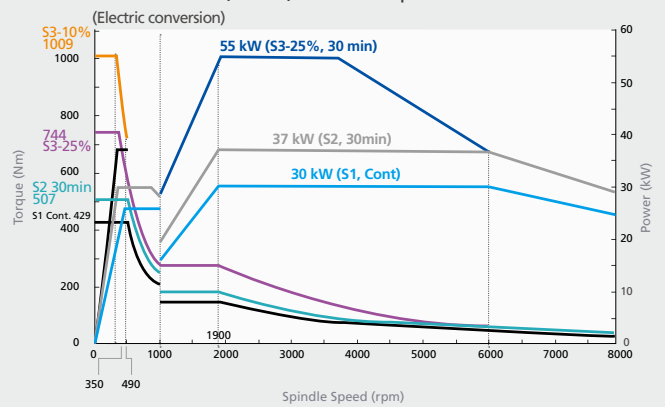

기계구성

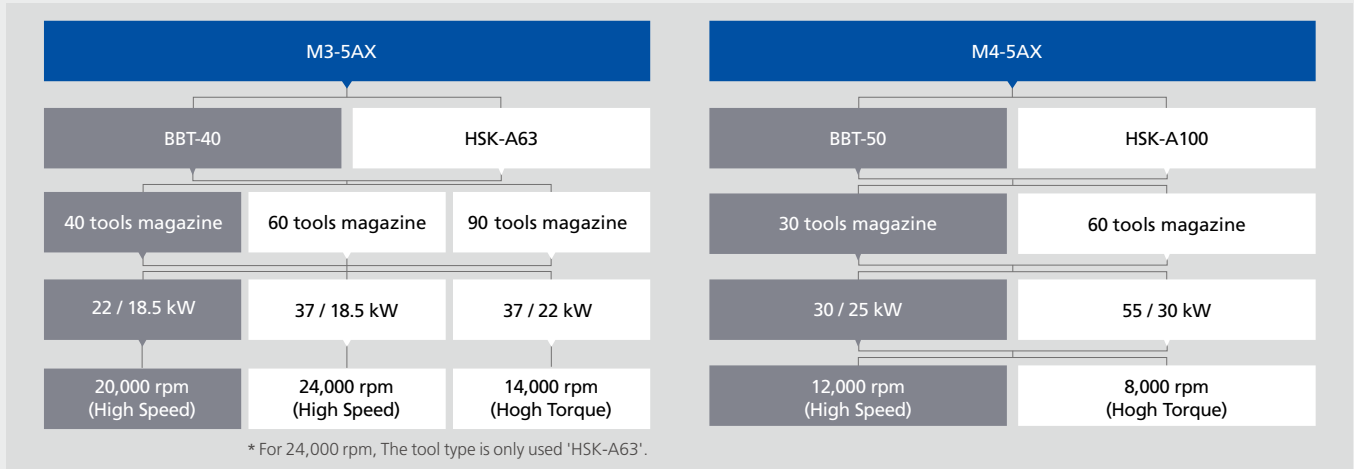

Machine Specifications

Item	M3-5AX			M4-5AX		
	20,000 rpm	24,000 rpm	14,000 rpm	12,000 rpm	8,000 rpm	
이송 량						
X-axis Stroke	mm (inch)	750 (29.53)		950 (34.4)		
Y-axis Stroke	mm (inch)	900 (35.43)		1,000 (39.37)		
Z-axis Stroke	mm (inch)	550 (21.65)		650 (25.59)		
A-axis tilt angle / C-axis rotation angle	deg	±120 / 360		±120 / 360		
Distance from Table Surface to Spindle Gauge Plane	mm (inch)	140 ~ 690 (5.51 ~ 27.17)		180 ~ 830 (7.09 ~ 32.68)		
Table						
Table Size	mm (inch)	Ø700 (Ø27.56) x 540 (21.26)		Ø800 x 630 (Ø31.5 x 24.8)		
Table Loading Capacity	Kg _f (lb _i)	800 (1,764)		1,200 (2,645)		
Table Surface Configuration (T slots W x P – No. of slots)	mm (inch)	18 x 100 (0.71 x 3.94) – 5ea		18 x 100 (0.71 x 3.94) - 5ea		
Spindle						
Max Spindle Speed	rpm	20,000	24,000	14,000	12,000	8,000
Spindle Motor	kW (HP)	22 / 18.5 (30 / 25)	37 / 18.5 (30 / 25)	37 / 22 (50 / 30)	30 / 25 (40 / 34)	55 / 30 (67 / 40)
Type of Spindle Taper Hole	-	BBT-40 (7/24 Taper)		BBT-50 (7/24 Taper)		
Spindle Bearing Inner Diameter	mm (inch)	Ø70 (Ø2.76)		Ø100 (8,000rpm only:Ø120)		
Method of Spindle Lubrication & Cooling	-	Oil-Jet Lubrication + Jacket Cooling		Oil-Jet Lubrication + Jacket Cooling		
Feed Rate						
Rapid Speed (X / Y / Z)	m/min (ipm)	48 / 48 / 40 (1,890 / 1,890 / 1,890)		36 / 36 / 30 (1,417 / 1,417 / 1,181)		
Rapid Speed (A / C)	rpm	30 / 40		20 / 30		
Feed (X / Y / Z)	mm/min (ipm)	X,Y: 1~24 (0.04 ~ 0.94) / Z: 1~20 (0.04 ~ 0.79)		24 / 24 / 24 (0.94 / 0.94 / 0.94)		
Motor						
Feed Motor(X / Y / Z / A / C)	kW(HP)	7 / 4 / 7 / 4 / 7 (9.4 / 5.4 / 9.4 / 5.4 / 9.4)		7 / 7 / 9 / 7 / 7 (9.3 / 9.3 / 12 / 9.3 / 9.3)		
Spindle Coolant Motor	kW(HP)	0.75 (1)		0.75 (1)		
Table Coolant Motor	kW(HP)	0.4 (0.5)		0.4 (0.5)		
ATC						
Type of Tool Shank	-	MAS-403 BBT-40 (OPT : CAT-40, HSK-A63, SK-40)		MAS-403 BBT-50 (OPT : CAT-50, HSK-A100, SK-50)		
Type of Pull Stud	-	MAS P40T-1 (45°)		MAS P40T-1 (45°)		
Tool Storage Capacity	ea	40 (OPT : 60, 90)		30 (OPT : 60)		
Max. Tool Diameter (With / Without Adjacent Tools)	mm (inch)	Ø80 (Ø3.15) / Ø100 (Ø3.94)		Ø120 / Ø230 (Ø4.72 / Ø9.06)		
Max. Tool Length	mm (inch)	320 (12.6)		400 (15.75)		
Max. Tool Weight	Kg _f (lb _i)	8 (17.64)		20 (44.1)		
Method of Tool Selection	-	Memory Random		Fixed Address		
Method of Operation	-	Servo Motor		Servo Motor		
Power Source						
Electric Power Supply	kVA	100		125		
Compressed Air Supply (Pressure x Consumption)	MPa	0.5 ~ 0.7		0.5 ~ 0.7		
Tank Capacity						
Spindle Cooling / Table Cooling	ℓ (gal)	80 (21.13) / 60 (15.85)		80 / 60 (21.13 / 15.85)		
Lubrication	ℓ (gal)	12 (3.17)		20 (5.28)		
Coolant	ℓ (gal)	350 (92.46)		350 (92.46)		
Machine Size						
Height	mm (inch)	3,582 (141.02)		4,252 (167.4)		
Floor Space (Length x Width)	mm (inch)	4,100 x 5,130 (161.42 x 201.97)		4,210 x 5,200 (165.75 x 204.72)		
Weight	Kg _f (lb _i)	21,000 (46,297)		28,000 (61,729)		
NC Controller		Fanuc 31i-B5				

NC Specifications [Fanuc 31i-B5]

※ S : Standard O : Option

Item	Specification	
Controlled Axis		
Controlled Axis	5 - Axes	S
Simultaneously Controlled Axes	5 - Axes	S
Least Input Increment	0.001 mm, 0.001 deg, 0.0001 inch	S
Least Input Increment 1 / 10	0.0001 mm, 0.0001 deg, 0.00001 inch	S
inch / metric Conversion	G20, G21	S
Store Stroke Check 1		S
Store Stroke Check 2		S
Mirror Image		S
Stored Pitch Error Compensation		S
Backlash Compensation		S
Operation		
Automatic & MDI Operation		S
DNC Operation by Memory Card	PCMCIA Card is Required	S
Program Number Search		S
Sequence Number Search		S
Dry Run, Single Block		S
Manual Handle Feed	1Unit	S
Manual Handle Feed Rate	x1, x10, x100	S
Handle Interruption		S
Interpolation Function		
Positioning	G00	S
Linear Interpolation	G01	S
Circular Interpolation	G02, G03	S
Dwell (Per Deconds)	G04	S
Cylindrical Interpolation	4-Axis Interface Option is Required	O
Helical Interpolation	Circular interpolation plus max 2 axes linear interpolation	S
Nano Smoothing		O
Reference Position Return Check	G27	S
Reference Position Return Return	G28, G29	S
2nd Reference Position Return	G30	S
Skip Function	G31	S
NURBS interpolation		O
Feed Function		
Rapid Traverse Override	F0, F25, F50, F100	S
Feedrate (mm/min)		S
Feedrate Override	0 ~ 200 %	S
Jog Feed Override	0 ~ 4,000 mm/min	S
Override Cancel	M48, M49	S
Program Input		
Tape Code	EIA RS244 / ISO840	S
Optional Block Skip	1 ea	S
Program Number	O4 - Digits	S
Sequence Number	N8 - Digits	S
Decimal Point Programming		S
Coordinate Dystem Detting	G92	S
Workpiece Coordinate System	G54 - G59	S
Workpiece Coordinate System Preset		O
Addition of Workpiece Coordinate Pair	48 ea	S
Addition of Workpiece Coordinate Pair	300 ea	O
Extend Program Edit Function	Copy / Move / Etc.	S
Manual Absolute ON and OFF		S
Chamfering / Corner R		S
Programmable Data Input	G10	S
Sub Program Call	10 Folds Nested	S
Custom Macro B		S
Addition of Custom Macro Common Variables	#100 - #199, #500 - #999	O
Canned Cycles for Drilling		S
Small-hole Peck Drilling Cycle		O
Automatic Corner Override		O
Feed Rate Clamp Based on Arc Radius		S
Scaling		O
Coordinate System Rotation		S
Polar Coordinate Command		O
Program Input		
Program Restart		O
Programm Mirror Image		O
Tape Format For FANUC Series 15		O
Manual Guide i		O
Spindle Speed Function		
Spindle Serial Output		S
Spindle Override	50-120 %	S
Spindle Orientation		S
Rigid Tapping		S
Tool Function / Compensation		
Tool Function	T4 - digits	S
Tool Offset Pairs	±6 - digits / 200 ea	S
Tool Offset Pairs	±6 - digits / 400 ea , 999 ea	O
Tool Offset Memory C		S
Tool Length Measurement		S
Cutter Compensation C		S
Tool Life Management		O
Tool Length Compensation		S
Editing Operation		
Part program Storage length / Number of Register Able Programs	256 kB / 500 ea	S
Part program Storage length / Number of Register Able Programs	512 kB / 1,000 ea 1 MB / 1,000 ea, 2 MB / 1,000 ea	O
Background Editing		S
Extended Part Program Editing		S
Play Back		O
Setting and Display		
Clock Function		S
Self-Diagnosis Function		S
Alarm History Display		S
Help Function		S
Graphic Function		S
Run Hour and Parts Count Display		S
Dynamic Garphic Display		O
Multi-language Display	English, German, French, Italian, Chinese, Spanish, Korean, Portuguese, Polish, Hungarian, Swedish, Russian	S
Data Input / Output		
Reader / Puncher Interface Ch1	RS232C	S
Data Server	256 MB	S
Data Server	1,024 MB	O
Ethernet Interface		S
Memory Card / USB Interface		S
Auto Data Backup	SRAM + Part Program	S
4-Axis Interface Function (Option)		
Controlled Axis	5- Axes	S
Simultaneously Controlled Axis	4- Axes	S
Control Axis Detach	5- Axes	S
Others		
Display Unit	10.4" Color LCD	S
HWACHEON Machining Software		
High Speed HRV3 Function		S
Hwacheon Artificial Intelligence Control System (HAI) - 600		S
Hwacheon Artificial Intelligence Control System (HAI) - 1000		O
Hwacheon Efficient Contour Control System (HECC)		S
Hwacheon Tool Load Detect System (HTLD)		S
Cutting Feed Optimization System (OPTIMA)		S
Hwacheon Rotation Center Calibration System (HRCCII)		O
Hwacheon Thermal Displacement Control System (HTDC)		S
Hwacheon Spindle Displacement Control System (HSDC) + Hwacheon Frame Displacement Control System (HFDC)		S
5Axis Intelligence		
Smooth Tool Center point control		S
Tilted working plane command with guidance for 5 axis		S
Work piece setting error compensation for 5 axis		S
Tool radius compensation for 5 axis		O

Hwacheon Global Network

 Hwacheon Headquarters  Hwacheon Europe  Hwacheon Asia  Hwacheon America



HWACHEON

Please call us for product inquiries.

www.hwacheon.com

The product design and specifications may change without prior notice.
Read the operation manual carefully and thoroughly before operating the product,
and always follow the safety instructions and warnings labels attached on the surfaces of the machines.

HEAD OFFICE

HWACHEON MACHINE TOOL CO., LTD.

123-17, HANAMSANDAN 4BEON-RO, GWANGSAN-GU, GWANGJU, KOREA
TEL: +82-62-951-5111 FAX: +82-62-951-0086

SEOUL OFFICE

46, BANGBAE-RO, SEOCHO-GU, SEOUL, KOREA
TEL: +82-2-523-7766 FAX: +82-2-523-2867

USA

HWACHEON MACHINERY AMERICA, INC.

555 BOND STREET, LINCOLNSHIRE, ILLINOIS, 60069, USA
TEL: +1-847-573-0100 FAX: +1-847-573-9900

SINGAPORE

HWACHEON ASIA PACIFIC PTE. LTD.

21 BUKIT BATOK CRESCENT, #08-79 WCEGA TOWER,
SINGAPORE 658065
TEL: +65-6515-4357 FAX: +65-6515-4358

GERMANY

HWACHEON MACHINERY EUROPE GMBH

JOSEF-BAUMANN STR. 25, 44805, BOCHUM, GERMANY
TEL: +49-234-912-816-0 FAX: +49-234-912-816-60

VIETNAM

HWACHEON MACHINE TOOL VIETNAM CO., LTD.

Unit 507, 5th Floor, Lot T2-4, D1 Road, Saigon Hi-Tech Park,
Tan Phu Ward, District 9, Ho Chi Minh City, Vietnam
TEL: +84 (0)961 288039